

THE CIRQUE 60" & 72" CEILING FAN INSTALLATION INSTRUCTIONS

Please read and save these instructions



**These instructions are to be used in
the installation of the following
QUORUM INTERNATIONAL fans...**

The Cirque 60" & 72"

QUORUM
INTERNATIONAL

© 2021 Quorum International. All Rights Reserved.

QUORUM'S UNIQUE LIMITED LIFETIME WARRANTY

This warranty gives you specific legal rights, and you may also have other rights which vary from state to state.

WHAT IS COVERED-

Except as specified below, the manufacturer of this product warrants it to be free of all defects in workmanship and material.

WHAT IS NOT COVERED BY THIS WARRANTY-

1. All costs of removal or reinstallation of the fan.
2. Damage resulting from failure to follow instructions contained herein.
3. Damage occurring during shipment of the product (claims must be presented to the carrier).
4. Damage resulting from accident, misuse, abuse, or neglect.
5. Damage resulting from the application of any exterior coating, or by the addition of any unapproved accessories.
6. Damage resulting from repair or attempted repair by anyone other than the manufacturer.
7. Damage resulting from causes other than product defects, including lack of

technical skill, competence, or experience of the user.

8. Glass or acrylic components or accessories.
9. Minor occurrences of wobble are accepted as normal and should not necessarily be considered a defect.

WHO MAY ENFORCE WARRANTY-

This warranty may be enforced only by the original purchaser. The end user must possess a dated proof of purchase from an authorized Quorum dealer to establish a warranty claim.

LENGTH OF THE WARRANTY -

1. For the fan motor - for the lifetime of the original purchaser.
2. For everything else, except blades and finish - one year from the date of purchase.
3. For fan blades and finish - 90 days from the date of purchase.

WHAT WE WILL PAY FOR -

We agree to correct defects outlined in the warranty without charge, or at our option replace the fan with an equivalent or superior product if the defective unit is returned prepaid to us.

TO GET WARRANTY SERVICE -

To obtain warranty service, the product

must be returned prepaid to Quorum. (This warranty is not enforceable outside the United States.) Details regarding return shipment are explained elsewhere in this manual. Whenever warranty service is required, **you must present a copy of the original dated sales receipt as proof of coverage.**

There is no other express warranty. Quorum hereby disclaims any and all implied warranties, including but not limited to those of merchantability of fitness for a particular purpose to the extent permitted by law. Quorum shall not be liable for incidental, consequential, or special damages arising out of or in connection with the product use or performance except as may otherwise be accorded by law. The duration of any implied warranty which cannot be disclaimed is limited to the periods specified above in the express warranty.

WARRANTY SERVICE

1. Most problems can be handled by our customer service agents over the telephone. Customers seeking warranty repair or replacement for any fan or component are encouraged to call us for assistance. All returns must be issued a Return Goods Authorization number (RGA) prior to returning the defective unit or part. Call (817) 626-5483 - Monday thru Friday 8:00 a.m. - 5:00 p.m. CST to obtain a RGA number.
2. Arriving shipments will be refused if they do not bear a valid RGA number on the outside packaging.

3. A dated proof of purchase must accompany any fan or component clearly indicating the name of the original purchaser.
4. To avoid damage in transit, the product should be returned in its original box and packaging. Quorum will not bear responsibility for any shipping damage.
5. Any return of a fan or component must be shipped freight and insurance prepaid.

FOR YOUR RECORDS

Purchased From _____
City _____ State _____
Fan Model No. _____
Date Purchased _____

Complete and mail the enclosed warranty card within 10 days to ensure your warranty is registered.

If you have any questions regarding the warranty, or the procedures for obtaining service, please call us at (817) 626-5483 - Monday thru Friday 8:00 a.m. - 5:00 p.m. CST.

1. SAFETY RULES

Model #46012-xx: 29.41 lbs
47212-xx: 33.51 lbs

1. To avoid possible electric shock, **turn off the electricity** at the main fuse box or circuit panel before you begin the fan installation or before servicing the fan or installing accessories.
2. Read all instructions and safety information carefully before installing your fan and **save these instructions**.
3. Make sure all electrical connections comply with local codes or ordinances as well as the National Electrical Code. If you are unfamiliar with electric wiring, please use a qualified and licensed electrician.
4. Make sure you have a location selected for your fan which allows clear space for the blades to rotate, and at least seven (7) feet of clearance between the floor and the fan blade tips.
5. The outlet box and ceiling support joist used must be securely mounted, and **capable of supporting at least 50 pounds**. To reduce the risk of fire, electric shock, or personal injury, use only an outlet box clearly labeled "**Acceptable For Fan Support**".
6. To reduce the risk of personal injury use only approved hanging brackets and screws supplied with the outlet box for mounting to the outlet box.
7. After installation is complete, check that all connections are absolutely secure.
8. Do not insert anything into the fan blades while they are rotating.
9. Do not operate the reverse switch until the fan has come to a complete stop.

10. Do not attempt to control the operation of the fan (or an optional light kit) from any wall control that is not approved by Quorum for use with its fans. Do not use solid state wall controls. The use of any unapproved control voids the fan's warranty.

TOOLS REQUIRED FOR INSTALLATION

Phillips Screwdriver
Wire Cutters
Electrical Tape
Step Ladder

2. UNPACKING YOUR FAN

Unpack your fan and check the contents. Do not discard the carton. If warranty replacement or repair is ever necessary the fan should be returned in original packaging. Remove all parts and hardware. Do not lay motor housing on its side - because the decorative casing may shift. Check all visible screws, bolts and nuts for tightness. Examine all parts. The following parts should be included:

1. Set of blades (a)
2. Set of blade arms (b)
3. Hanger plate (c)
4. Hanger/mounting bracket (d)
5. Canopy (e)
6. Canopy cover (f)
7. Downrod assembly (6") (g)
8. Yoke cover (h)
9. Fan motor assembly (i)
10. Mounting plate (j)
11. 18W LED light kit (k)
12. Plastic shade (l)
13. Light kit decorative cover (m)
14. Receiver incl. 5 wire nuts (n)
15. Battery (o)
16. Wall transmitter incl. 2 mounting screws and 3 wire nuts (p)
17. 2 wall plates (white and almond), 1 face plate (almond), 2 sets of mounting screws, and machine screws (q)
18. Parts bags (r) containing:
 - Blade attachment hardware (screws/washers, washers may be attached to screws)
 - Blade arm attachment hardware (screws with lock washers, screws)
 - Mounting hardware (wire nuts, wood screws, machine screws, lock washers, spring washers, metal washers.)
19. Blade balancing kit (s)

NOTE:

Some Quorum fan models will have slightly different parts than what is shown here depending upon the design you have chosen. Basic installation procedures are similar for all models.

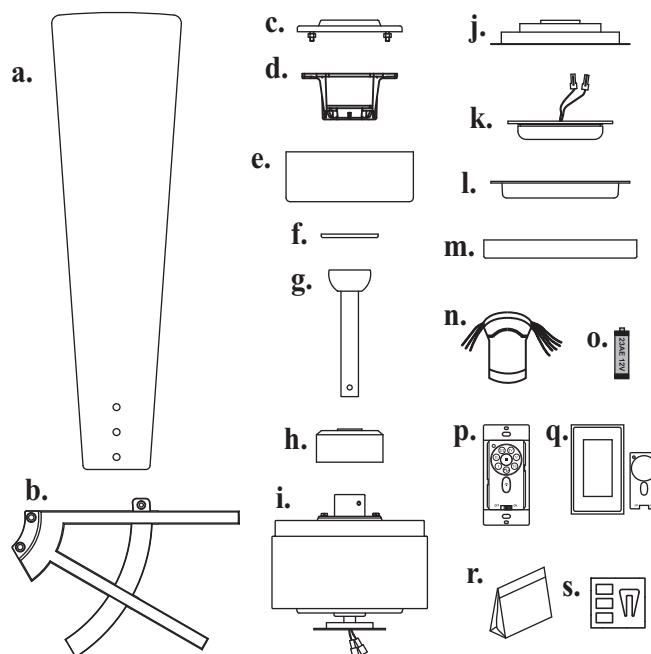

IF YOU FIND THAT PARTS ARE MISSING, CONTACT YOUR DEALER FOR REPLACEMENT, OR CALL QUORUM DIRECTLY AND WE WILL MAIL REPLACEMENTS TO YOU IMMEDIATELY.

3. MOUNTING OPTIONS

1. Disconnect the power by removing fuses or turning off circuit breakers.

2. If there is an existing outlet box, ensure it is clearly marked "Suitable for Fan Support". If it is not so marked, it must be replaced with an approved one.

3. Secure the outlet box (or make sure the existing box is secured) directly to the building structure. Use appropriate fasteners and building materials.

4. Figures 1,2 and 3 are examples of different ways to mount the outlet box in different situations. A longer downrod may be required in sloped ceiling situations to maintain proper blade clearance.

5. To hang the fan in locations where no ceiling joist is available, a hanger support bar may be required (Figure 4). Contact your local dealer for support bars and outlet boxes.

WARNING: TO REDUCE THE RISK OF ELECTRIC SHOCK, FIRE, OR PERSONAL INJURY, MOUNT THE FAN ONLY TO AN OUTLET MARKED ACCEPTABLE FOR FAN SUPPORT AND USE MOUNTING SCREWS PROVIDED WITH THE OUTLET BOX.

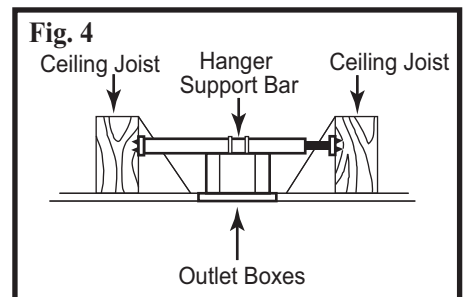
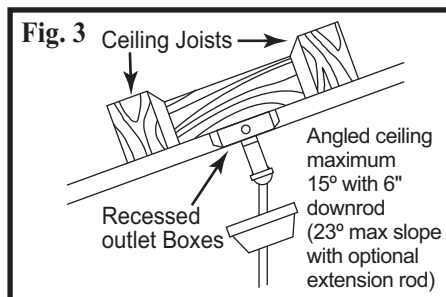
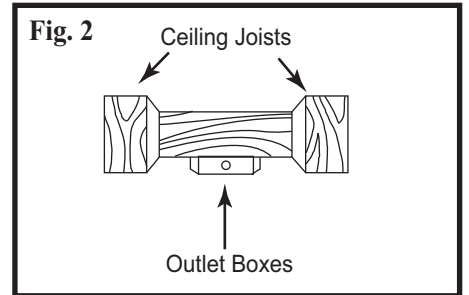
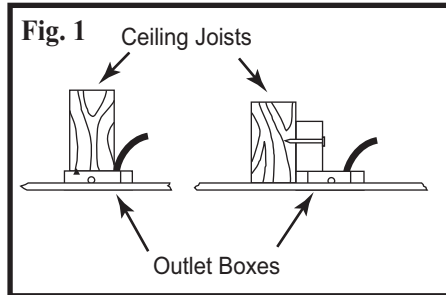

CAUTION: TO REDUCE THE RISK OF PERSONAL INJURY, INSTALL THE PRIMARY MOUNTING MEANS AND USE ONLY THE HARDWARE PROVIDED WITH THE FAN.

4. HANGING YOUR FAN

WARNING - Turn off the power!

DO NOT fasten the blades to the fan until it is assembled and hanging from the ceiling. To do so now will likely bend the blade arms and almost certainly cause wobble.

1. Use the two wood screws and washers provided to secure the hanger bracket plate directly to the building joist via the knockout holes from the outlet box. (Fig. 5)

NOTE: For easy installation and to avoid the possibility of the wood screws breaking in half, pre-drill two 4mm diameter holes with power tool in the wood joist before installing the wood screws.

CAUTION: The hanger bracket plate must be installed directly to the building joist using the two wood screws and washers provided.

2. Secure hanger bracket to hanger bracket plate using the two hex nuts and washers provided, make sure nuts are securely tighten. (Fig. 6)

CAUTION: ALL PARTS ASSEMBLY SHOULD BE WORKED AT THE FLOOR.

3. Remove the set pin and safety lock clip from the yoke on top of the motor assembly. Slide the downrod through the canopy and canopy cover. Slide the yoke cover onto the downrod (Fig. 7). Feed the wires and safety cable from the fan motor through the downrod assembly.

4. (Fig. 8) Attach the downrod assembly (downrod, yoke cover, canopy and canopy cover) to the motor by sliding the downrod into the yoke on top of the motor assembly. Slide the set pin through the hole in the yoke, downrod and secure it with the safety lock clip. Tighten the set screws on yoke. The yoke cover will lower down to conceal the yoke. Feed the wires through the downrod ball.

5. Lift the fan motor without the blades and place into the hanger bracket, rotating the ball until the groove engages the tab on the hanger bracket. This locks the ball mount and fan motor, preventing fan rotation during operation. (Fig. 9)

6. Secure the safety cable to the building structure using a wood screw (not included). (Fig. 9)

Fig. 5

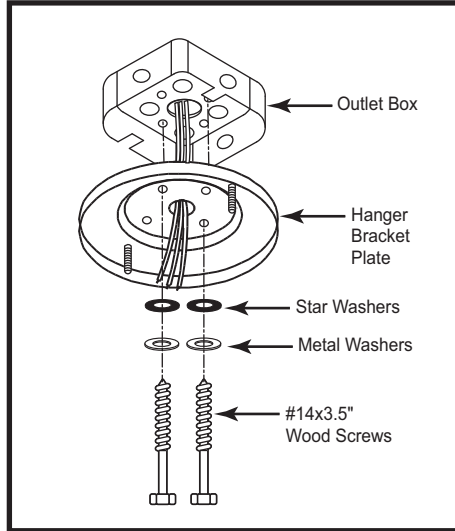

Fig. 6

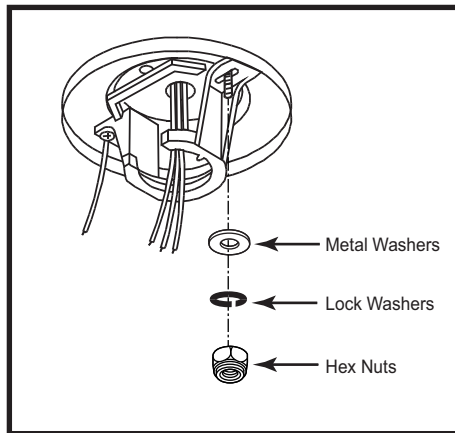

Fig. 7

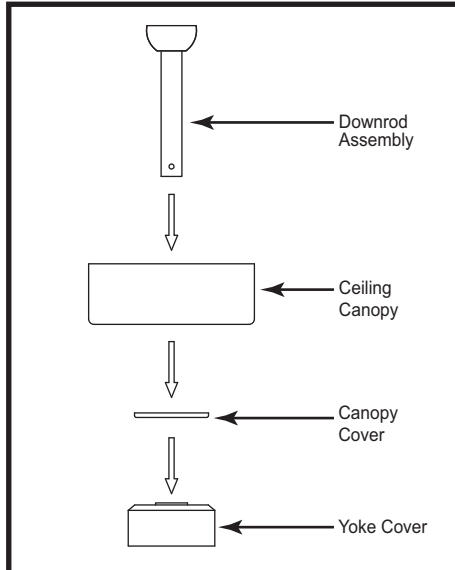

Fig. 8

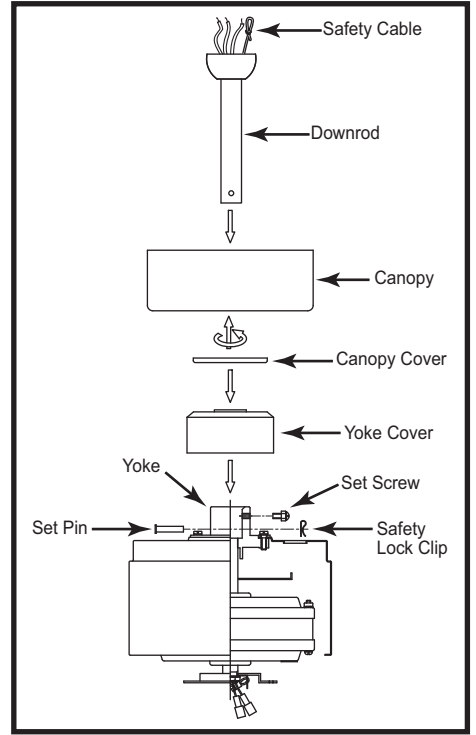
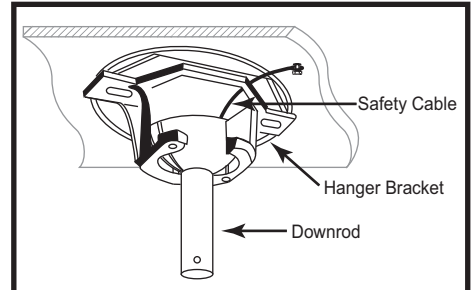

Fig. 9



5. ELECTRICAL CONNECTIONS

REMEMBER - Turn off the power! **NOTE** - Control must be installed within 30 feet of fan.

Use the wire nuts supplied with your fan when making connections. Secure the connectors with electrical tape and make sure there are no loose connections or wire strands.

1. Make wire connections from the fan to the wall control receiver unit. For this step use the bundle of 5 wires on the receiver. (Fig. 10)

- Connect the YELLOW fan wire to the YELLOW receiver wire.
- Connect the GRAY fan wire to the GRAY receiver wire.
- Connect the RED fan wire to the RED receiver wire.
- Connect the WHITE fan wire to the WHITE receiver wire.
- Connect the BLUE fan wire to the BLUE receiver wire.

2. Connect the wiring from the ceiling to the receiver unit. (Use the 2 wire bundle on the receiver.) Secure with supplied wire nuts.

- Connect the BLACK building supply wire to the BLACK receiver wire.
- Connect the WHITE receiver neutral wire to the WHITE building neutral wire.
- Connect the COPPER building ground wire to the YELLOW / GREEN fan ground wire. Also connect the two GREEN wires (from fan) to building ground wire.

3. Connect the wiring from the wall switch receptacle to wall transmitter unit.

- Remove the existing wall plate and switch from the wall junction box.
- Connect one BLACK wire from the wall to one BLACK wire (labeled "TO FAN") from the wall transmitter.
- Connect the other BLACK wire (labeled "TO POWER SUPPLY") from the transmitter to the remaining BLACK wire from the wall (A/C supply source).

If your junction box has a ground wire (green or bare copper), connect the transmitter's ground wire to it. Otherwise, connect the transmitter ground wire directly to one of the screws from the outlet box.

Carefully tuck the connected wires inside the junction box. Secure the transmitter with the two screws provided. Attach the face plate over the transmitter with the two screws provided.

4. Put the receiver unit inside the canopy. Proceed to Step 6 - Completing the Installation.

Use **ONLY** wall controls approved by Quorum. Use of unapproved wall controls will cause unacceptable humming noise, and avoids the fan warranty.

Fig. 10

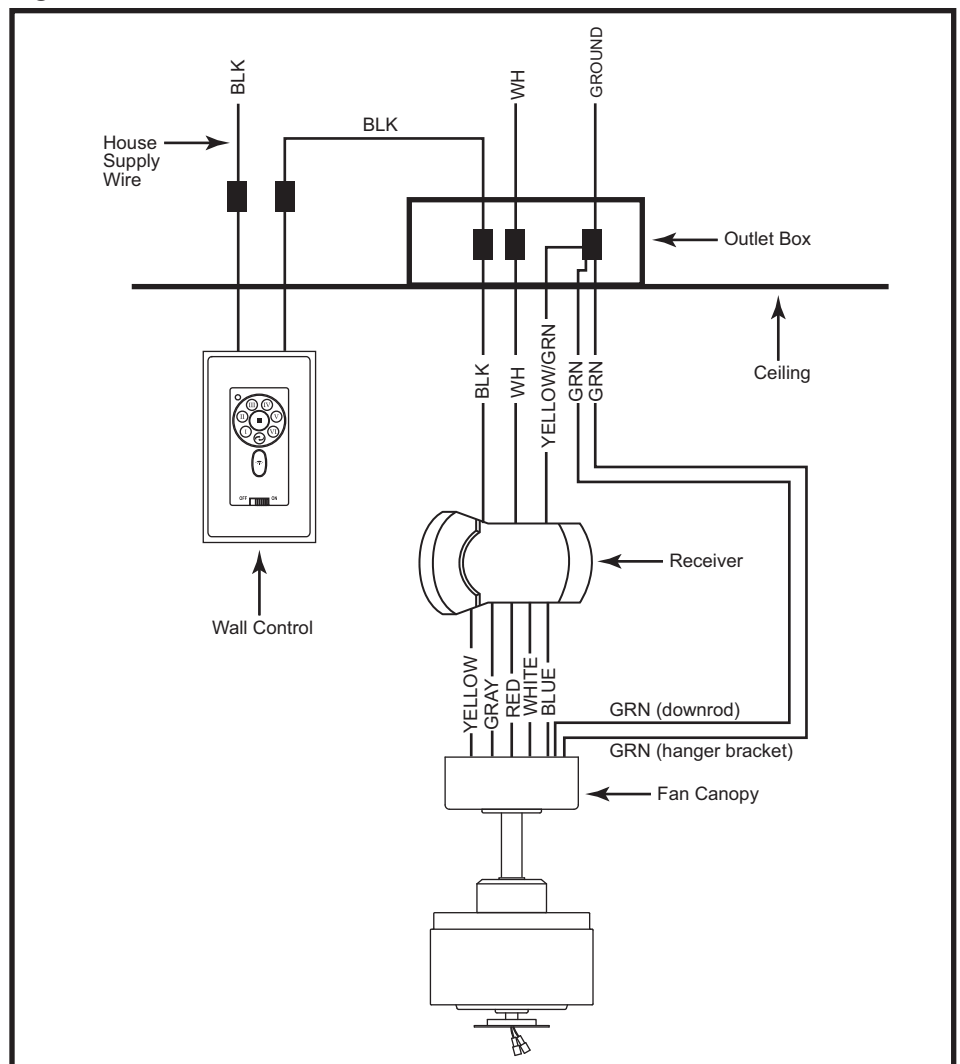

6. COMPLETING THE INSTALLATION

WARNING - Turn off the power!

1. Make sure the wiring is safely inside the outlet box as instructed in **Step 5 - Electrical Connections**. To install the canopy, remove one of the two screws from the bottom of the mounting bracket and loosen the other screw one turn. Slide the canopy up to mounting bracket and place the key hole on the canopy over the screw on the mounting bracket, turn canopy until it locks in place at the narrow section of the key holes. Secure by tightening the two set screws. **NOTE:** Adjust the canopy screws as necessary until the canopy and canopy cover are snug. **WARNING:** Make sure tab at bottom of hanger bracket is properly seated in groove of hanger ball before attaching canopy to bracket. Failure to properly seat tab in groove could cause damage to electrical wiring. (Fig. 11)

2. **Blade Assembly & Installation (Fig. 12)**
Using the supplied blade arm screws, attach the blades to the blade arms. In some cases the rubber washer is permanently fixed to the screw head. Ensure all screws are used for each blade. Next attach the blades to the motor assembly using the supplied screws. **DO NOT bend the blade arms when installing the blades.**

3. **Attaching the Mounting Plate (Fig. 13)**
Connect the two wiring plugs from the motor assembly to the corresponding plugs in the light kit. Attach the light kit to the mounting plate by using the three (3) screws provided that are preinstalled on the mounting plate.

4. **Attaching the LED Light Kit (Fig. 14)**
Attach the mounting plate to the flange of the motor by using the three (3) screws provided that are preinstalled on the flange.

5. **Attaching the plastic shade and light kit decorative cover (Fig. 15)**
Raise plastic shade up against mounting plate and secure it to the fan by using the two (2) screws provided that are preinstalled on the mounting plate. Raise light kit decorative cover up against the plastic shade, and secure it to fan by turning light kit decorative cover clockwise until snug. **DO NOT OVERTIGHTEN.**

A certain amount of wobble may be considered normal, especially if the fan is on a downrod long than 12".

Fig. 11

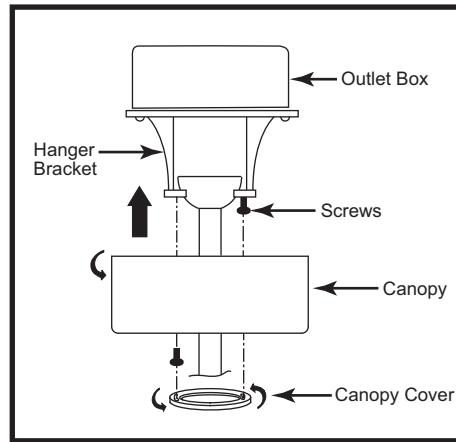

Fig. 14

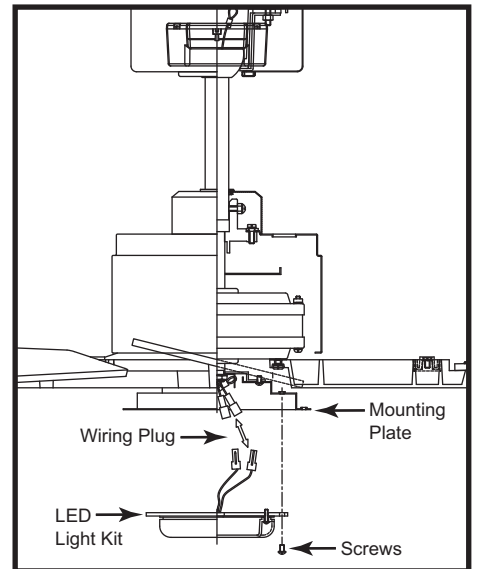

Fig. 12

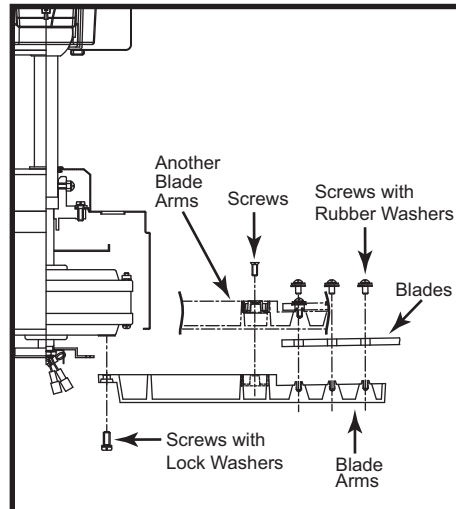

Fig. 15

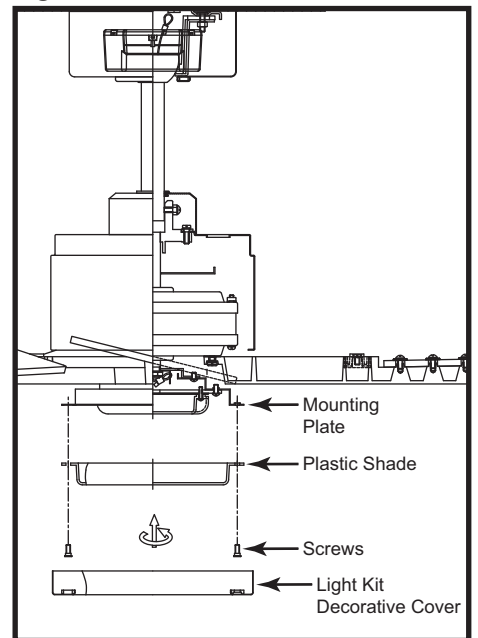
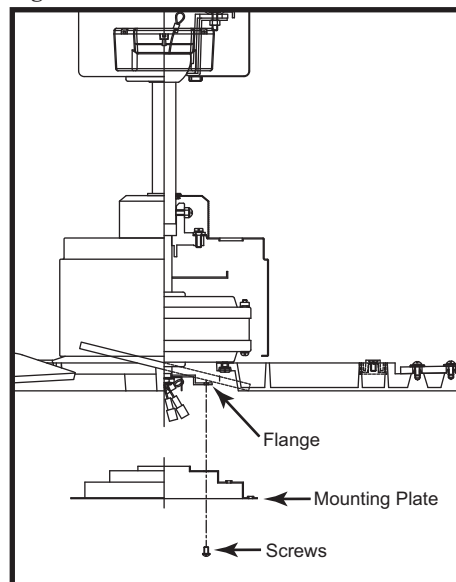

Fig. 13



7. INSTALLING THE WALL CONTROL

REMEMBER - Turn off the power! **NOTE** - Control must be installed within 30 feet of fan.

1. Remove the existing wall plate and switch from the wall junction box.
2. If your outlet box has a ground wire (green or bare copper) connect the wall control's ground wire to it; otherwise connect the wall control's ground wire directly to one of the screws from the outlet box.

3. (Fig. 16) Carefully tuck the wire connections inside the junction box. Secure the wall control with the two screws provided. Attach the wall plate over the wall control and secure with the two screws provided.

Fig. 16

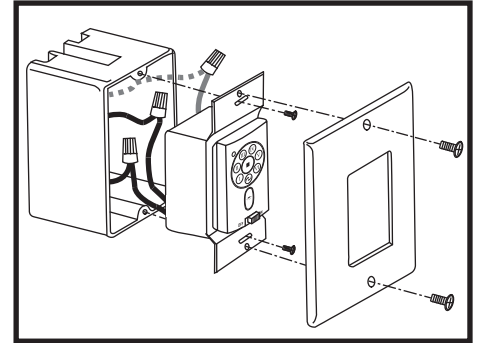

8. OPERATING YOUR TRANSMITTER

Your DC brushless motor is equipped with an automatically learned type remote control. There are no frequency switches on the receiver; the receiver unit will automatically scan the frequency from the wall control if any changes are made. The frequency settings on the transmitter should be changed only in case of interference or if a second or more ceiling fans with the same type of control system are installed in the same structure. (Fig. 16) (If two fans or more in a house, it is recommended that you not use the factory code settings. Change codes setting to any other combination of dip switch setting to avoid fan interference issues, but users need to do control setting process as below once the code setting is changed. Please refer the "SET" code setting button section.)

Remove the panel from the transmitter and then install one 23A/12V battery (included). To prevent damage to transmitter, remove the battery if not use for long periods of time (Fig. 17).

- I, II, III, IV, V and VI buttons:**
These six buttons are used to set the fan speed as follows:
I = minimum speed
II = low speed
III = medium low speed
IV = medium speed
V = medium high speed
VI = high speed
- button:**
This button turns the fan off.
- ↻ Reverse button:**
This button is to control fan direction. This button must be pressed while fan is running (suggested speed IV).

- Light button:**
This button is to control optional light. Switch the "D" and "ON" dip switch on the front of transmitter to decide the light in "ON/OFF" or "Dimmable" condition.
- "D" and "ON" dip switch:**
The "ON" selection is the light dimmable selection and is to be used with all bulbs except for CFL bulbs. The "D" selection is the light on only (no dimmable function) and is to be used with CFL and LED bulbs as CFL bulbs cannot be dimmed properly.
- Code setting button:**
Code dip switch.
- "SET" code setting button:**
Follow the below steps to use the set button. (Fig. 17)
- ON - OFF Slide button:** Power switch. (Fig. 18)
- Signal light** (Fig. 18)

Pairing Process

With the fan's power off, arrange code switches to desired code setting only if the factory pre-set code (all 4 dip switches in "on" position) will not be used. Restore power to the fan. Press and hold "SET" button for about 5 seconds and release. If optional light kit is installed, the light kit will flash twice and the signal light on the wall control will come on when the button is pressed. The fan has completed the pairing process with the wall control and is ready for use.

NOTE: The "SET" button must be pressed within 60 seconds of restoring power.

NOTE: A single fan can be controlled with as many as 3 wall controls in one room. Every control will need to repeat the pairing process based on instructions above and all controls must be within 30 feet of the fan.

Fig. 17

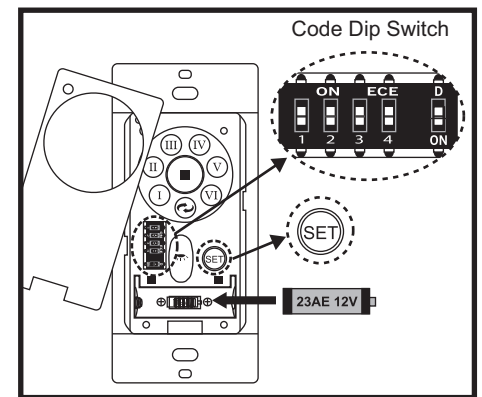
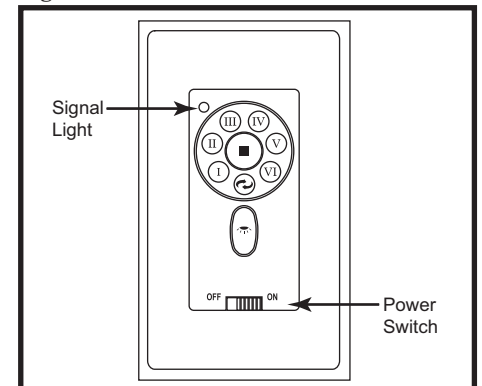

Fig. 18



8. OPERATING YOUR TRANSMITTER (continued)

NOTE: If multiple fans are installed on the same circuit, each fan must have its own switch leg. Each fan and wall control pair must have its own wire from the control to the fan (the wire from the control to the fan can NOT be shared). There can NOT be a jumper wire running from fan to fan.

The receiver provides the following protective function:

1. **Lock position:** The DC motor has a built-in safety against obstruction during operation. The motor will be locked operation and disconnect power after 30 seconds of interruption. Please remove obstacles before re-set.
2. **Over 80W protection:** When the receiver detects motor power consumption which is greater than 80W, the receiver power will be stopped and operation will immediately discontinue. Turn the receiver power on after 5 seconds.

9. FAN OPERATION AND CARE

1. A ceiling fan is an environmentally smart choice to cool as well as to help warm your home or office. Adjust your HVAC thermostat during fan use to save additional energy and money on your air conditioning and heating utility bills. You should see a significant reduction in both your heating and cooling costs by regular use of your fan.

Do not hesitate to use your fan during summer and winter months. In summer, (Fig. 19) using the reverse switch, adjust the fan's direction so cool air is blown down, producing a cooling breeze. In winter, (Fig. 20) reverse the fan so that an upward airflow will push warm air off the ceiling and circulate it downwards into the living area. In winter months, use the fan at a lower speed than summer.

2. Periodically check tightness of all screws securing the blades to the blade arm attachment points. A clicking or a rattling noise is a sure indication of loosening screws. Since screws will invariably work loose over time, at least once a year, tighten all the screws attaching blades to blade arms. **Do not bend blade arms when cleaning or servicing the fan.**

3. Clean your fan periodically using only a cloth dampened with a mild detergent solution for all hardware - never use solvents. The finish plating is lacquered to prevent tarnishing. Use a lint-free cloth with clean water to clean blades.

4. You will never need to oil or lubricate your fan. Its permanently sealed bearings will provide trouble free, silent operation for many years.

5. If repairs or servicing are ever required, to avoid possible electric shock, **turn off the electricity** at the main fuse or circuit panel before you begin.

Fig. 19

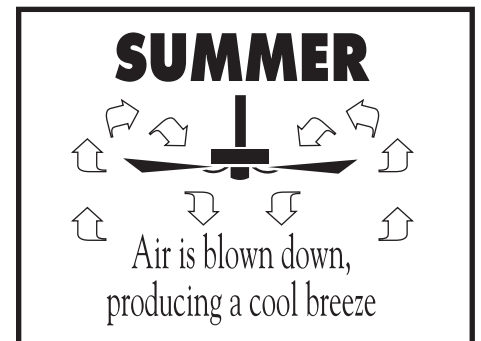
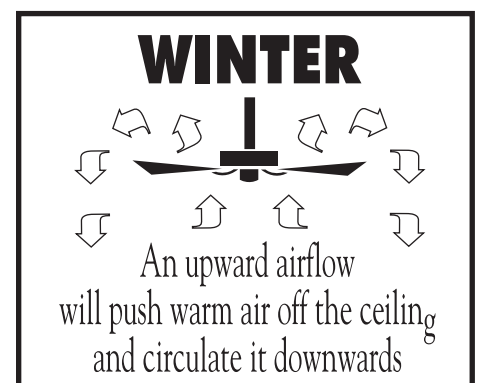

Fig. 20



10. TROUBLESHOOTING

FAN WILL NOT START

1. Check that the electricity has been turned on at the circuit breaker which had probably been turned off during installation.
2. Turn off the electricity. Check all connections in the wiring of the fan at the ceiling and make sure it follows the wiring instructions outlined in this manual.
3. Be sure ON/OFF power switch on the wall control is in ON position.
4. Be sure the wall control is installed within 30 feet of ceiling fan.

NOISE

Note: Always allow a day or two "run-in" time for any new fan at medium or high speed. When attempting to diagnose noise, listen carefully from several sides to try and isolate the location of the noise (blade, upper end, motor, light kit, etc.)

1. Tighten all screws attaching blades to blade arms. Remember to tighten these screws at least once a year because they may loosen slowly over time and cause a clicking noise.
2. Turn off the power. Loosen the canopy and check that the wiring and/or wire nut connectors are not resting against the canopy, possibly vibrating while the fan is on.

3. Use of a standard light rheostat or an unapproved fan wall control to control the fan speed will always cause an annoying "hum". Many fan motors do not work quietly with solid state variable speed controls.

4. Check that the rubber gasket on the mounting bracket has been installed if called for in the installation instructions.

5. Check that the canopy is not touching the ceiling.

6. Check that all screws on the motor housing and the bottom housing are tight.

FAN TURNS, BUT DOES NOT MOVE MUCH AIR

1. The fan may be running in reverse. Press the reverse button on transmitter to set the fan in forward operation.
2. The distance from the ceiling to the blades may be too small. For downrod fans, optimal placement would be 8-9 feet from the floor.
3. The room may contain items which obstruct the air flow.
4. The fan may be too small for the size of the room.

EXCESSIVE WOBBLE

Note: A small amount of wobble is considered acceptable and should not be considered a defect.

1. Make certain all blades are tightly attached to each blades' respective blade arm.

REPLACEMENT PARTS

For replacement parts, contact your local dealer.